

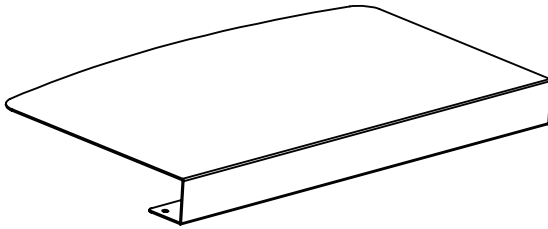

---

## Desk Corner Connector

### Instruction Manual



**SKU: DESK-AC07S**



Scan the QR code with your mobile device or follow the link for helpful videos and specifications related to this product.

**<https://vivo-us.com/products/desk-ac07s>**

---

**GET IN TOUCH** | Monday-Friday from 7:00am-7:00pm CST



help@vivo-us.com



www.vivo-us.com  
*Chat live with an agent!*



309-278-5303



## WARNING

If you do not understand these directions, or if you have any doubts about the safety of the installation, please call a qualified technician. Check carefully to make sure there are no missing or defective parts. Improper installation may cause damage or serious injury. Do not use this product for any purpose that is not explicitly specified in this manual and do not exceed weight capacity. We cannot be liable for damage or injury caused by improper mounting, incorrect assembly, or inappropriate use.

## ! WARNING: CHOKING HAZARD

SMALL PARTS - NOT FOR CHILDREN UNDER 3 YEARS. ADULT SUPERVISION IS REQUIRED.

## PACKAGE CONTENTS



**A** (x1)  
Desk Sleeve



**S-A** (x4)  
M5x35mm  
Screw



**S-B** (x3)  
M5x8mm  
Screw



**S-C** (x2)  
M6x8mm  
Screw



**S-D** (x6)  
Washer



**S-E** (x12)  
Spacer

**NOTE:** SOME HARDWARE MAY NOT BE USED

## TOOLS NEEDED



**Phillips  
Screwdriver**



**Tape Measure**



**Drill**

## ASSEMBLY STEPS

### OPTION A: Regular Mounting

Place Desk Sleeve (**A**) on the desktop at the desired location. Measure the space between the underside of the desktop and the lower portion of the sleeve to determine the required Spacers (**S-E**) and Washers (**S-D**) for mounting. Drill 10mm deep pilot holes in the desktop for the desk sleeve and the rear end of the keyboard mount using a 3mm (1/8") drill bit. Install using M5x35mm Screws (**S-A**) and previously counted Washers (**S-D**) and Spacers (**S-E**).

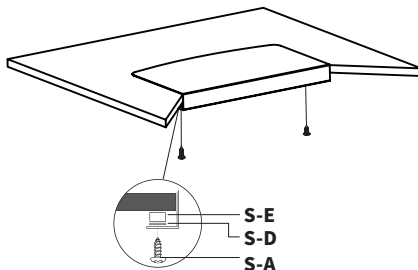
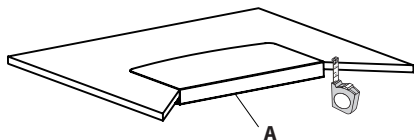

## OPTION B: Mounting with Keyboard Tray

Place Desk Sleeve (**A**) on the desktop at the desired location. Measure the space between the underside of the desktop and the lower portion of the sleeve to determine the required Spacers (**S-E**) and Washers (**S-D**) for mounting. Remove Desk Sleeve (**A**) from the desktop.

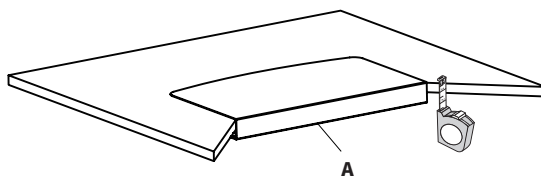

Install front end of the keyboard mount (not provided) to Desk Sleeve (**A**) using either the M5x8 Screws (**S-B**) or M6x8 Screws (**S-C**), depending on the keyboard mount to be installed. Tighten with a Phillips screwdriver.

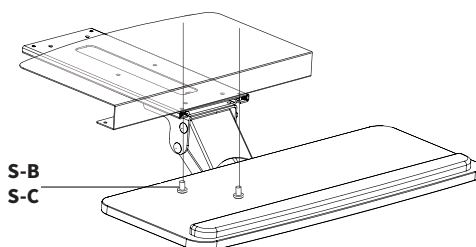

Fit Desk Sleeve (**A**) with keyboard mount to the desktop. Drill 10mm deep pilot holes in the desktop for the desk sleeve and the rear end of the keyboard mount using a 3mm (1/8") drill bit.

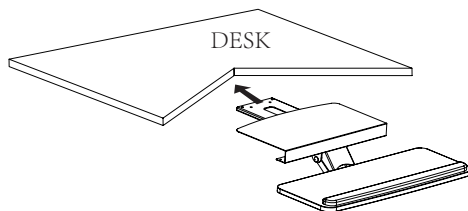

Secure Desk Sleeve (**A**) and keyboard mount to the desk using M5x35 Screws (**S-A**) and previously counted Spacers (**S-D**) and Washers (**S-E**). Tighten with a Phillips screwdriver.

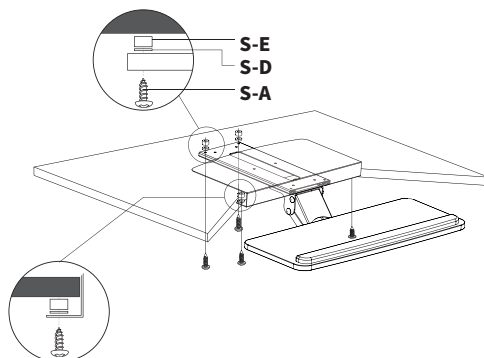



Open **Monday - Friday 7:00am - 7:00pm** CST,  
our dedicated support team can offer immediate assistance with rapid response times. If any parts are received damaged or defective, please contact us. We are happy to replace parts to ensure you have a fully functioning product.



309-278-5303

**AVG. RESOLUTION TIME** (*within office hrs*): **5M 4S**



[www.vivo-us.com](http://www.vivo-us.com)  
*Chat live with an agent!*

**AVG. RESOLUTION TIME** (*within office hrs*): **< 15 M**



[help@vivo-us.com](mailto:help@vivo-us.com)

**AVG. RESPONSE TIME** (*within office hrs*): **1HR 8M**

- 23% within < 15m
- 38% within < 30m
- 61% within < 1hr
- 83% within < 2hr
- 92% within < 3hr